

For **WATERPROOFED ROOFS OR EXISTING UPSTANDS**

# SKYCLAIR®

CE  
EN 1873 + A1: 2016



## Types of filling

### THERMIK' RANGE:

- PCA 16
- PCA 16+
- PCA 32
- PCA 32+
- Acoustik' Light



## Upstand

- Straight upstand
- 1.2 mm galvanised steel

### THERMIK' RANGE:

- Height 360 mm with a 30 mm bituminous insulating coating



THERMIK'

## VERSION

The SKYCLAIR® is a skylight intended for waterproofed flat roofs on all types of buildings (including public facilities, work premises and industrial buildings).

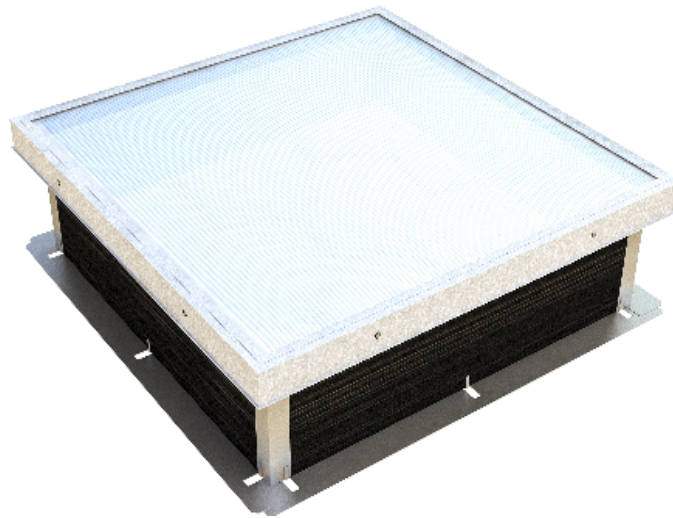

Also available:



RPT



ORIGIN'

## OPTIONS



### Types of filling

- Opal PCA 16 IR
- Grey PCA 16
- Transparent PCA 16



### Upstand

- Upstand height: 410 mm or more
- Lacquered interior (standard RAL colours)
- Colaminated sheet steel top for PVC waterproofing
- Galvanised sheet steel top for PVC waterproofing
- Bare insulation for PVC waterproofing

### Capping upstand

See page 4 for details.

### Available versions



ACOUSTIK'



### Other information

- 6 mm round bar or 16x16 mm 1200 joule square tube grid, galvanised or lacquered in standard RAL
- Anti-sawing burglar-resistant grid (16x16 mm + R10 tube assembly), galvanised or lacquered in standard RAL
- Pleated blind for horizontal installation in the product, for 100 x 100 cm and 120 x 120 cm dimensions (contact us for other dimensions) with an upstand height of at least 500 mm

## Dimensions

| Roof opening dimensions<br>A x B (cm) | Overall heel dimensions<br>C x D (cm) | Height H* (cm) | Light surface<br>(m <sup>2</sup> ) | Product weight<br>(kg) |
|---------------------------------------|---------------------------------------|----------------|------------------------------------|------------------------|
| 50 x 50                               | 68 x 68                               | 37             | 0.25                               | 22                     |
| 85 x 85                               | 103 x 103                             | 38             | 0.73                               | 37                     |
| 100 x 100                             | 118 x 118                             | 38             | 1.00                               | 44                     |
| 120 x 120                             | 138 x 138                             | 38             | 1.44                               | 53                     |
| 140 x 140                             | 158 x 158                             | 38             | 1.96                               | 62                     |
| 150 x 150                             | 168 x 168                             | 38             | 2.25                               | 66                     |
| 160 x 160                             | 178 x 178                             | 40             | 2.56                               | 70                     |
| 180 x 180                             | 198 x 198                             | 40             | 3.24                               | 79                     |
| 70 x 100                              | 88 x 118                              | 37             | 0.70                               | 37                     |
| 100 x 140                             | 118 x 158                             | 38             | 1.40                               | 53                     |
| 100 x 150                             | 118 x 168                             | 38             | 1.50                               | 55                     |
| 100 x 200                             | 118 x 218                             | 40             | 2.00                               | 66                     |
| 140 x 200                             | 158 x 218                             | 40             | 2.80                               | 75                     |
| 120 x 250                             | 138 x 268                             | 40             | 3.00                               | 81                     |
| 150 x 300                             | 168 x 318                             | 38             | 4.50                               | 99                     |
| 160 x 250                             | 178 x 268                             | 38             | 4.00                               | 90                     |
| 195 x 200                             | 213 x 218                             | 40             | 3.90                               | 87                     |
| 195 x 250                             | 213 x 268                             | 40             | 4.88                               | 98                     |
| 195 x 300                             | 213 x 318                             | 40             | 5.85                               | 109                    |

Contact us for other dimensions.

\* Stated base dimensions have a tolerance of +/- 5 mm.

## Filling performance

Other filling and filling options: see "Filling" data sheet.

| Type of filling | Thermal transmittance factor Ug<br>(W/ m <sup>2</sup> .K) | LT D65 <sup>(2)</sup> | SF or g <sup>(2)</sup> | Reaction to fire | R <sub>w</sub> (dB) <sup>(3)</sup> |                       |
|-----------------|---|-----------------------|------------------------|------------------|------------------------------------|-----------------------|
|                 | U <sub>hor</sub> <sup>(1)</sup>                           |                       |                        |                  |                                    |                       |
| PCA             | Opal multi-wall PCA 16                                    | 1.9                   | 45%                    | 46%              | B-s1-d0                            | R <sub>w</sub> =21 dB |
|                 | Transparent PCA 16 with Lumira™ aerogel                   | 1.5                   | 67%                    | 67%              | B-s1-d0                            | R <sub>w</sub> =21 dB |
|                 | Opal multi-wall PCA 20                                    | 1.6                   | 54%                    | 47%              | B-s2-d0                            | R <sub>w</sub> =21 dB |
|                 | Transparent multi-wall PCA 32                             | 1.3                   | 33%                    | 49%              | B-s2-d0                            | ND                    |
|                 | Transparent PCA 32 with 50% Lumira™ aerogel               | 0.97                  | 43%                    | 45%              | ND                                 | ND                    |
| Acoustik'Light  | Acoustik'Light<br>Transparent PCA 10 & transparent PCA 6  | 2.1                   | ND                     | ND               | ND                                 | ND                    |

<sup>(1)</sup>Relative to the horizontal, as per §2.31 of the Th-Bat regulations.

<sup>(2)</sup>Light transmittance LT D65 and solar transmittance SF (TST or g) as per EN 410.

<sup>(3)</sup>Filling insulated against airborne noise R<sub>w</sub>, pink noise R<sub>k</sub> (environment, airport and industrial activities) and road noise R<sub>AV</sub>, laboratory-measured according to NF EN ISO 140.

## Technical diagrams

### THERMIK' range

SKYCLAIR PCA

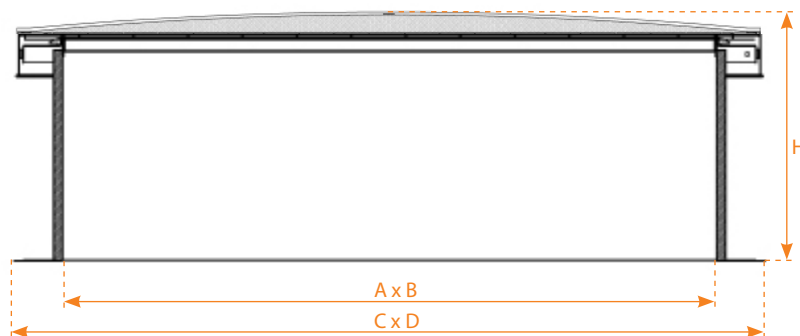

### THERMIK' range capping upstand

SKYCLAIR PCA

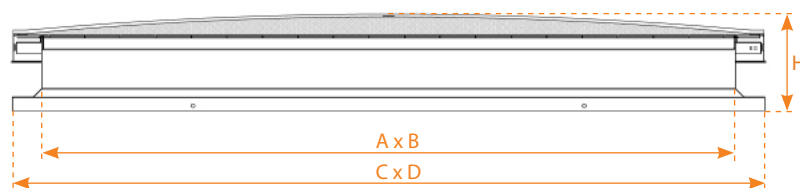

## COMPLIANCE & INSTALLATION

Compliant with EU standard **NF EN 1873**.

The product must be fastened and sealed in accordance with the requirements defined in the applicable DTU specifications (series 40 and 43).

Maximum insulation height: as per the DTUs, the sealing flashing must extend to a height of at least 150 mm.

For the THERMIK' range, the waterproofing complex (substrate, vapour barrier, insulation and two-layer sealant) must be: no thicker than 125 mm for an interior upstand height of 310 mm, 175 mm for an interior upstand height of 360 mm, or 225 mm for an interior upstand height of 410 mm.

Maximum permissible slope: 25° or 46% (see installation instructions).

Only the security bar option provides guaranteed 1200 joule protection.

DoP available at [www.skydome.eu](http://www.skydome.eu)

## Trade name

| Trade name | Filling                 | Upstand insulation   |
|------------|-------------------------|--|
| SKYCLAIR   | THERMIK' 16             | 16 mm PCA (Opal PCA)   |
|            | THERMIK' 16+            | 16 mm PCA with LUMIRA (Transparent PCA)  |
|            | THERMIK' 20             | 20 mm PCA (Opal PCA)   |
|            | THERMIK' 20+            | 20+ mm PCA with LUMIRA (Transparent PCA)   |
|            | THERMIK' 32             | 32 mm PCA (Transparent PCA)  |
|            | THERMIK' 32+            | 16 mm PCA + 16 mm PCA with LUMIRA (Transparent PCA)  |
|            | THERMIK' ACOUSTIK'LIGHT | 10 mm PCA + 6 mm solid PC  |
|            |                         | Upstand height: 360 mm<br>Insulation:<br><ul style="list-style-type: none"> <li>on vertical part of upstand</li> <li>on upstand lip</li> </ul> |

## Air permeability and light surface

| Roof opening dimensions<br>A x B (cm) | Air flow (m <sup>3</sup> /h) - Class AP06 <sup>(1)</sup> |                 | ELS <sup>(2)</sup> (m <sup>2</sup> ) |                |
|---------------------------------------|--|-----------------|--------------------------------------|----------------|
|                                       | Less than 4 Pa   | Less than 50 Pa | Upstand 360 mm                       | Upstand 410 mm |
| 50 x 50                               | 0.18   | 2.46            | 0.07                                 | 0.07           |
| 85 x 85                               | 0.31   | 4.18            | 0.25                                 | 0.24           |
| 100 x 100                             | 0.36   | 4.92            | 0.36                                 | 0.35           |
| 120 x 120                             | 0.43   | 5.90            | 0.54                                 | 0.52           |
| 140 x 140                             | 0.50   | 6.89            | 0.75                                 | 0.73           |
| 150 x 150                             | 0.54   | 7.38            | 0.86                                 | 0.85           |
| 160 x 160                             | 0.58   | 7.87            | 0.99                                 | 0.98           |
| 180 x 180                             | 0.65   | 8.86            | 1.27                                 | 1.25           |
| 70 x 100                              | 0.71   | 9.72            | 0.24                                 | 0.23           |
| 100 x 140                             | 0.31   | 4.18            | 0.52                                 | 0.51           |
| 100 x 150                             | 0.43   | 5.90            | 0.56                                 | 0.55           |
| 100 x 200                             | 0.45   | 6.15            | 0.76                                 | 0.74           |
| 140 x 200                             | 0.61   | 8.36            | 1.09                                 | 1.07           |
| 120 x 250                             | 0.67   | 9.10            | 1.16                                 | 1.14           |
| 150 x 300                             | 0.81   | 11.07           | 1.78                                 | 1.76           |
| 160 x 250                             | 0.74   | 10.09           | 1.58                                 | 1.56           |
| 195 x 200                             | 0.71   | 9.72            | 1.54                                 | 1.52           |
| 195 x 250                             | 0.80   | 10.95           | 1.95                                 | 1.92           |
| 195 x 300                             | 0.89   | 12.18           | 2.35                                 | 2.32           |

<sup>(1)</sup> Air permeability tests carried out at the CSTC test centre as per NF EN 1873 protocols (with reference to the standards NF EN 12152 and NF EN 12153).

<sup>(2)</sup> Effective light surface calculated with white lacquered upstand and PCA 16 filling

# Acoustic performance

|   | PCA 16   | PCA 16+  | PCA 20 | PCA 32    | PCA 32+ | Acoustik' Light |
|---|----------|----------|--------|-----------|---------|-----------------|
| Acoustic attenuation $R_w$ ( $C; C_{tr}$ ) (dB) | 19(-2;2) | 19(0;-1) | ND     | 20(-2;-1) | 21(0;0) | 25(-1;-1)       |
| Rain-generated sound intensity $L_{ia}$ (dB)    | 77       | 74       | ND     | 75        | 72      | 66              |

$R_w$  = acoustic attenuation index laboratory-measured according to EN410 (airborne noise) -  $R_p = R_w + C$  = "pink noise" attenuation index -  $R_{A,r} = R_w + C_r$  = "road noise" attenuation index  
 \*Overall performance of the unit fitted with ACOUSTIK' LIGHT filling is stated for the CONFORT and ELITE ranges only

Product  $U_{RC} : 1.2 \text{ W/m}^2.\text{K}^*$

ENHANCED THERMAL INSULATION

- ✓ Wide range of filling options
- ✓  $U_{RC} = 1.2 \text{ W/m}^2.\text{K}^*$
- ✓ Compliant with applicable DTU specifications

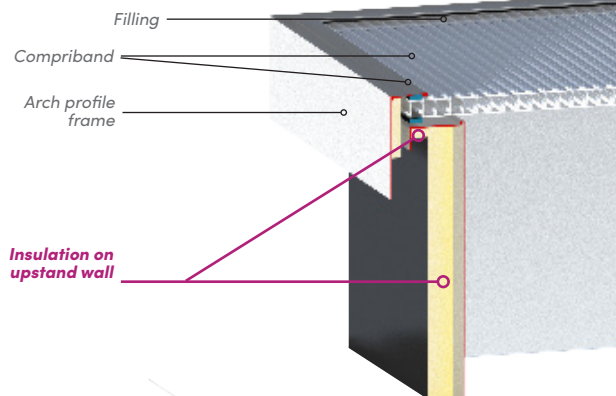

Thermal performance:  $U_{RC}$  ( $\text{W/m}^2.\text{K}$ ) and  $A_{RC}$  ( $\text{m}^2$ )

| SKYCLAIR®       |                        |        |         |        |          |            |                              |             |                 |                        |          |         |        |          |            |                              |             |      |  |          |
|-----------------|------------------------|--------|---------|--------|----------|------------|------------------------------|-------------|-----------------|------------------------|----------|---------|--------|----------|------------|------------------------------|-------------|------|--|----------|
| Dimensions (cm) | Upstand height: 360 mm |        |         |        |          |            |                              |             |                 | Upstand height: 410 mm |          |         |        |          |            |                              |             |      |  |          |
|                 | $U_{RC}$               |        |         |        |          |            |                              |             |                 | $A_{RC}$               | $U_{RC}$ |         |        |          |            |                              |             |      |  | $A_{RC}$ |
|                 | Acoustik' Light        | PCA 16 | PCA 16+ | PCA 20 | PCA 32** | PCA 32+ ** | Opaque 40 mm aluminium cover | Triple dome | Acoustik' Light |                        | PCA 16   | PCA 16+ | PCA 20 | PCA 32** | PCA 32+ ** | Opaque 40 mm aluminium cover | Triple dome |      |  |          |
| 50 x 50         | 2                      | 1.7    | 1.6     | 1.6    | 1.5      | 1.4        | 1.4                          | 2.1         | 1.2             | 1.6                    | 1.6      | 1.5     | 1.5    | 1.5      | 1.4        | 1.4                          | 2.2         | 1.3  |  |          |
| 85 x 85         | 2                      | 1.7    | 1.6     | 1.6    | 1.5      | 1.3        | 1.3                          | 2.2         | 2.2             | 1.7                    | 1.6      | 1.5     | 1.5    | 1.5      | 1.4        | 1.3                          | 2.3         | 2.4  |  |          |
| 70 x 100        | 2                      | 1.7    | 1.6     | 1.6    | 1.5      | 1.3        | 1.3                          | 2.2         | 7.2             | 1.7                    | 1.6      | 1.5     | 1.5    | 1.5      | 1.4        | 1.3                          | 2.3         | 7.6  |  |          |
| 100 x 100       | 2                      | 1.7    | 1.5     | 1.6    | 1.5      | 1.3        | 1.3                          | 2.3         | 2.7             | 1.7                    | 1.6      | 1.5     | 1.5    | 1.5      | 1.4        | 1.3                          | 2.4         | 2.9  |  |          |
| 120 x 120       | 2                      | 1.7    | 1.5     | 1.6    | 1.5      | 1.3        | 1.2                          | 2.3         | 3.5             | 1.8                    | 1.7      | 1.5     | 1.5    | 1.4      | 1.3        | 1.2                          | 2.4         | 3.7  |  |          |
| 140 x 140       | 1.9                    | 1.7    | 1.5     | 1.6    | 1.4      | 1.3        | 1.2                          | 2.4         | 4.3             | 1.8                    | 1.7      | 1.5     | 1.5    | 1.4      | 1.3        | 1.2                          | 2.4         | 4.6  |  |          |
| 150 x 150       | 1.9                    | 1.7    | 1.5     | 1.6    | 1.4      | 1.2        | 1.2                          | 2.4         | 4.7             | 1.8                    | 1.7      | 1.5     | 1.5    | 1.4      | 1.3        | 1.2                          | 2.4         | 5.1  |  |          |
| 160 x 160       | 1.9                    | 1.7    | 1.5     | 1.6    | 1.4      | 1.2        | 1.2                          | 2.4         | 5.2             | 1.8                    | 1.7      | 1.5     | 1.5    | 1.4      | 1.3        | 1.2                          | 2.5         | 5.6  |  |          |
| 180 x 180       | 1.9                    | 1.7    | 1.5     | 1.6    | 1.4      | 1.2        | 1.2                          | 2.4         | 6.2             | 1.8                    | 1.7      | 1.5     | 1.5    | 1.4      | 1.3        | 1.2                          | 2.5         | 6.6  |  |          |
| 195 x 200       | 1.9                    | 1.8    | 1.5     | 1.6    | 1.4      | 1.2        | 1.2                          | /           | 7.2             | 1.8                    | 1.7      | 1.5     | 1.5    | 1.4      | 1.3        | 1.2                          | /           | 7.6  |  |          |
| 200 x 200       | /                      | /      | /       | /      | /        | /          | /                            | 2.4         | /               | /                      | /        | /       | /      | /        | /          | /                            | 2.5         | /    |  |          |
| 100 x 140       | 2                      | 1.7    | 1.5     | 1.6    | 1.5      | 1.3        | 1.2                          | 2.3         | 2.2             | 1.8                    | 1.6      | 1.5     | 1.5    | 1.4      | 1.3        | 1.3                          | 2.4         | 2.3  |  |          |
| 100 x 150       | 2                      | 1.7    | 1.5     | 1.6    | 1.5      | 1.3        | 1.2                          | 2.3         | 3.4             | 1.8                    | 1.7      | 1.5     | 1.5    | 1.4      | 1.3        | 1.3                          | 2.4         | 3.7  |  |          |
| 100 x 200       | 1.9                    | 1.7    | 1.5     | 1.6    | 1.4      | 1.3        | 1.2                          | 2.4         | 4.5             | 1.8                    | 1.7      | 1.5     | 1.5    | 1.4      | 1.3        | 1.3                          | 2.4         | 4.8  |  |          |
| 120 x 200       | 1.9                    | 1.7    | 1.5     | 1.6    | 1.4      | 1.2        | 1.2                          | 2.4         | /               | 1.8                    | 1.7      | 1.5     | 1.5    | 1.4      | 1.3        | 1.2                          | 2.5         | /    |  |          |
| 140 x 200       | 1.9                    | 1.7    | 1.5     | 1.6    | 1.4      | 1.2        | 1.2                          | 2.4         | 5.6             | 1.8                    | 1.7      | 1.5     | 1.5    | 1.4      | 1.3        | 1.2                          | 2.5         | 6.0  |  |          |
| 120 x 250       | 1.9                    | 1.7    | 1.5     | 1.6    | 1.4      | 1.2        | 1.2                          | /           | 6.1             | 1.8                    | 1.7      | 1.5     | 1.5    | 1.4      | 1.3        | 1.2                          | 2.5         | 6.4  |  |          |
| 150 x 300       | 1.9                    | 1.8    | 1.5     | 1.6    | 1.4      | 1.2        | 1.2                          | /           | 8.2             | 1.8                    | 1.7      | 1.5     | 1.5    | 1.4      | 1.3        | 1.2                          | /           | 8.7  |  |          |
| 160 x 250       | 1.9                    | 1.8    | 1.5     | 1.6    | 1.4      | 1.2        | 1.2                          | /           | 7.4             | 1.8                    | 1.7      | 1.5     | 1.5    | 1.4      | 1.3        | 1.2                          | /           | 7.8  |  |          |
| 195 x 250       | 1.9                    | 1.8    | 1.5     | 1.6    | 1.4      | 1.2        | 1.2                          | /           | 8.5             | 1.8                    | 1.7      | 1.5     | 1.5    | 1.4      | 1.2        | 1.2                          | /           | 9.0  |  |          |
| 195 x 300       | 1.9                    | 1.8    | 1.5     | 1.6    | 1.4      | 1.2        | 1.2                          | /           | 9.9             | 1.8                    | 1.7      | 1.5     | 1.5    | 1.4      | 1.2        | 1.2                          | /           | 10.4 |  |          |

\* For a 195 x 250 cm unit with a 410 mm high upstand and PCA 32+ filling

FOR RENOVATION AND COMPLIANCE WORKS

The SKYCLAIR® CAPPING UPSTAND is designed to fit any type of upstand, whether for compliance reasons or to change the unit's purpose **while retaining the existing upstand.**



**Filling**

- PCA 16
- PCA 16+
- PCA 32
- PCA 32+
- Acoustik' Light



**Upstand**

- Bevelled adapter upstand with 84 mm heel and 40 mm overlap
- 1.2 mm galvanised steel
- Height 170 mm

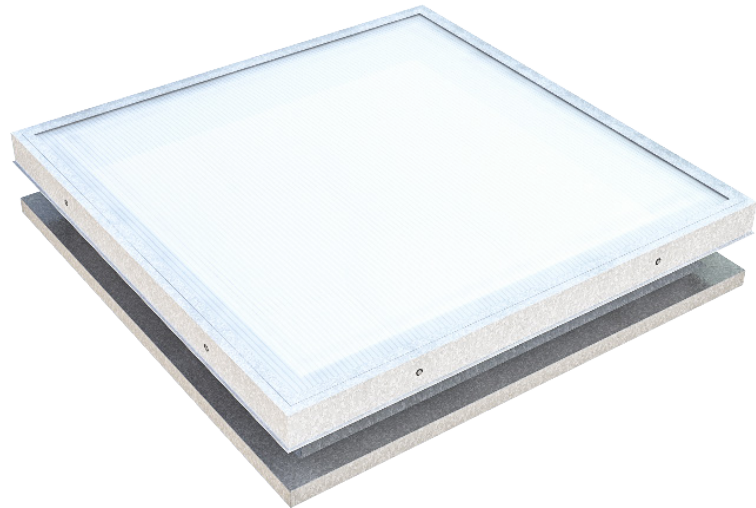

**Installation diagram**

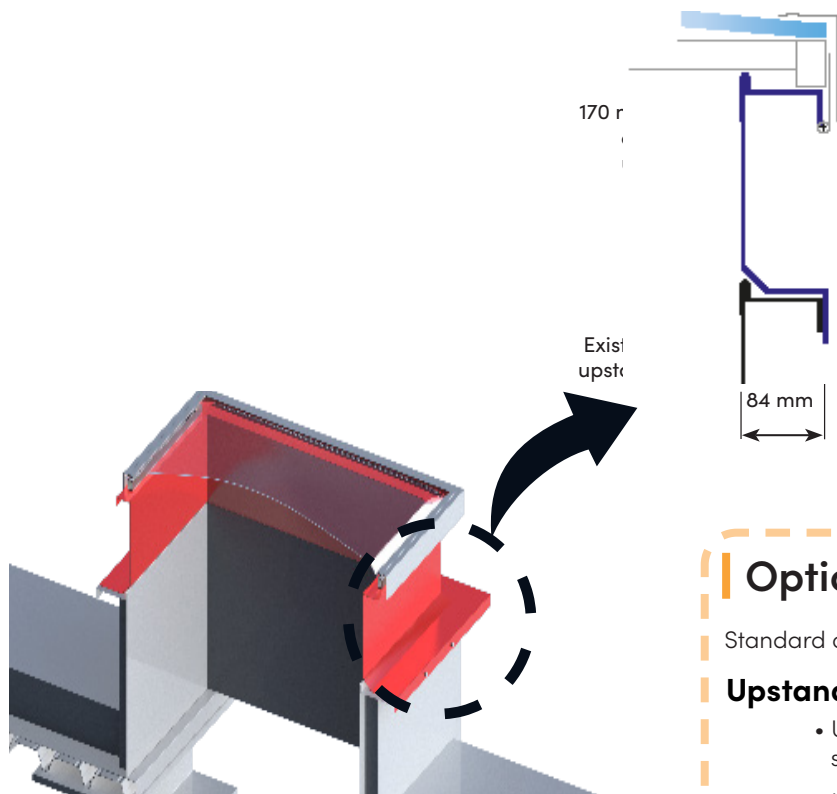

**Options**

Standard options list p.1

**Upstand**

- Upstand insulation including a galvanised steel protection plate
- Heel width on request for fitting to existing substrate
- Upstand height on request

## Dimensions

| Roof opening dimensions<br>A x B (cm) | Overall heel dimensions<br>C x D (cm) | Height H* (cm) | Light surface<br>(m <sup>2</sup> ) | Product weight (kg) |
|---------------------------------------|---------------------------------------|----------------|------------------------------------|---------------------|
| <b>50 x 50</b>                        | <b>67 x 67</b>                        | 22             | 0.25                               | 17                  |
| <b>85 x 85</b>                        | <b>102 x 102</b>                      | 23             | 0.73                               | 29                  |
| <b>100 x 100</b>                      | <b>117 x 117</b>                      | 23             | 1.00                               | 34                  |
| <b>120 x 120</b>                      | <b>137 x 137</b>                      | 23             | 1.44                               | 40                  |
| <b>140 x 140</b>                      | <b>157 x 157</b>                      | 23             | 1.96                               | 47                  |
| <b>150 x 150</b>                      | <b>167 x 167</b>                      | 23             | 2.25                               | 50                  |
| <b>160 x 160</b>                      | <b>177 x 177</b>                      | 23             | 2.56                               | 54                  |
| <b>180 x 180</b>                      | <b>197 x 197</b>                      | 25             | 3.24                               | 60                  |
| <b>70 x 100</b>                       | <b>87 x 117</b>                       | 24             | 0.70                               | 29                  |
| <b>100 x 140</b>                      | <b>117 x 157</b>                      | 22             | 1.40                               | 40                  |
| <b>100 x 150</b>                      | <b>117 x 167</b>                      | 23             | 1.50                               | 42                  |
| <b>100 x 200</b>                      | <b>117 x 217</b>                      | 23             | 2.00                               | 50                  |
| <b>140 x 200</b>                      | <b>157 x 217</b>                      | 25             | 2.80                               | 57                  |
| <b>120 x 250</b>                      | <b>137 x 267</b>                      | 25             | 3.00                               | 62                  |
| <b>150 x 300</b>                      | <b>167 x 317</b>                      | 25             | 4.50                               | 76                  |
| <b>160 x 250</b>                      | <b>177 x 267</b>                      | 25             | 4.00                               | 69                  |
| <b>195 x 200</b>                      | <b>212 x 217</b>                      | 25             | 3.90                               | 66                  |
| <b>195 x 250</b>                      | <b>212 x 267</b>                      | 25             | 4.88                               | 75                  |
| <b>195 x 300</b>                      | <b>212 x 317</b>                      | 25             | 5.85                               | 83                  |

Contact us for other dimensions. \* For an upstand height of 170 mm



Thermal performance:  $U_{RC}$  (W/m<sup>2</sup>.K) and  $A_{RC}$  (m<sup>2</sup>)

| SKYCLAIR® capping upstand |                    |        |         |        |          |            |                                       |                |          |
|---------------------------|--------------------|--------|---------|--------|----------|------------|---------------------------------------|----------------|----------|
| Dimensions<br>(cm)        | THERMIK'           |        |         |        |          |            |                                       |                |          |
|                           | $U_{RC}$           |        |         |        |          |            |                                       |                | $A_{RC}$ |
|                           | Acoustik'<br>Light | PCA 16 | PCA 16+ | PCA 20 | PCA 32** | PCA 32+ ** | Opaque<br>40 mm<br>aluminium<br>cover | Triple<br>dome |          |
| 50 x 50                   | 3                  | 2.7    | 2.5     | 2.4    | 2.3      | 2.2        | 2                                     | 2.6            | 0.7      |
| 85 x 85                   | 2.8                | 2.6    | 2.3     | 2.2    | 2.1      | 1.9        | 1.8                                   | 2.8            | 1.5      |
| 70 x 100                  | 2.8                | 2.5    | 2.3     | 2.2    | 2.1      | 1.9        | 1.8                                   | 2.8            | 5.6      |
| 100 x 100                 | 2.7                | 2.5    | 2.2     | 2.2    | 2        | 1.8        | 1.7                                   | 2.8            | 1.9      |
| 120 x 120                 | 2.6                | 2.4    | 2.2     | 2.1    | 2        | 1.7        | 1.6                                   | 2.8            | 2.5      |
| 140 x 140                 | 2.5                | 2.4    | 2.1     | 2.1    | 1.9      | 1.7        | 1.6                                   | 2.8            | 3.2      |
| 150 x 150                 | 2.5                | 2.3    | 2.1     | 2      | 1.9      | 1.6        | 1.5                                   | 2.8            | 3.6      |
| 160 x 160                 | 2.4                | 2.3    | 2.1     | 2      | 1.9      | 1.6        | 1.5                                   | 2.8            | 4.0      |
| 180 x 180                 | 2.4                | 2.3    | 2       | 2      | 1.9      | 1.6        | 1.5                                   | 2.8            | 4.8      |
| 195 x 200                 | 2.4                | 2.3    | 2       | 2      | 1.8      | 1.5        | 1.4                                   | /              | 5.7      |
| 200 x 200                 | /                  | /      | /       | /      | /        | /          | /                                     | 2.8            | /        |
| 100 x 140                 | 2.6                | 2.4    | 2.2     | 2.1    | 2        | 1.7        | 1.7                                   | 2.8            | 1.5      |
| 100 x 150                 | 2.6                | 2.4    | 2.2     | 2.1    | 2        | 1.7        | 1.6                                   | 2.8            | 2.5      |
| 100 x 200                 | 2.5                | 2.4    | 2.1     | 2.1    | 1.9      | 1.7        | 1.6                                   | 2.8            | 2.6      |
| 120 x 200                 | 2.5                | 2.3    | 2.1     | 2      | 1.9      | 1.6        | 1.5                                   | 2.8            | /        |
| 140 x 200                 | 2.4                | 2.3    | 2       | 2      | 1.8      | 1.6        | 1.5                                   | 2.8            | 4.3      |
| 120 x 250                 | 2.4                | 2.3    | 2       | 2      | 1.8      | 1.6        | 1.5                                   | /              | 4.6      |
| 150 x 300                 | 2.4                | 2.3    | 2       | 2      | 1.8      | 1.5        | 1.4                                   | /              | 6.5      |
| 160 x 250                 | 2.4                | 2.3    | 2       | 2      | 1.8      | 1.5        | 1.4                                   | /              | 5.8      |
| 195 x 250                 | 2.4                | 2.2    | 1.9     | 1.9    | 1.7      | 1.5        | 1.4                                   | /              | 6.8      |
| 195 x 300                 | 2.4                | 2.2    | 1.9     | 1.9    | 1.7      | 1.5        | 1.4                                   | /              | 8.0      |

\* For a 195 x 200 cm unit with a 410 mm high upstand and PCA 32+ filling

---

**SKYDÔME**

Entre Deux Villes  
02270 Sons-Et-Ronchères, France  
Tel: +33 (0)3 23 21 79 90  
Email: [info@skydome.eu](mailto:info@skydome.eu)  
[www.skydome.eu](http://www.skydome.eu)

For the product range in other countries, please contact your local representative or visit [www.skydome.eu](http://www.skydome.eu).

SKYDÔME reserves the right to modify product specifications without notice. The information and technical details contained in this documentation are provided in good faith and apply to the uses described. The recommendations for use must be checked to ensure they are appropriate and comply with the actual requirements, the specifications and all applicable legislation and regulations.

For other applications and conditions of use, please contact our technical team. Their advice must be sought concerning uses of our products that are not described specifically herein.

Click this link to check that you are seeing the most up-to-date and accurate information about our products: [https://www.skydome.eu/fr/produit/8\\_skyclair.html](https://www.skydome.eu/fr/produit/8_skyclair.html)

For **WATERPROOFED ROOFS OR EXISTING UPSTANDS**

# SKYCLAIR®

CE  
EN 1873 + A1: 2016

## ORIGIN' VERSION



### Filling

- ORIGIN' RANGE:**
- Opal PCA 10



### Upstand

- Straight upstand
- 1.2 mm galvanised steel

**ORIGIN' RANGE:**

- Height 310 mm with a 15 mm bituminous insulating coating

The SKYCLAIR® is a skylight intended for waterproofed flat roofs on all types of buildings (including public facilities, work premises and industrial buildings).



Also available:



## OPTIONS



### Types of filling

- Grey PCA 10
- Transparent PCA 10



### Upstand

- Upstand height: 360 mm, 410 mm or more
- Lacquered interior (standard RAL colours)
- Colaminated sheet steel top for PVC waterproofing
- Galvanised sheet steel top for PVC waterproofing
- Bare insulation for PVC waterproofing



### Other information

- 6 mm round bar or 16x16 mm 1200 joule square tube grid, galvanised or lacquered in standard RAL
- Anti-sawing burglar-resistant grid (16x16 mm + R10 tube assembly), galvanised or lacquered in standard RAL
- Pleated blind for horizontal installation in the product

### Capping upstand

See page 4 for details.

### Available versions



## Dimensions

| Roof opening dimensions<br>A x B (cm) | Overall heel dimensions<br>C x D (cm) | Height H* (cm) | Light surface<br>(m <sup>2</sup> ) | Product weight<br>(kg) |
|---------------------------------------|---------------------------------------|----------------|------------------------------------|------------------------|
| 50 x 50                               | 68 x 68                               | 36             | 0.25                               | 22                     |
| 85 x 85                               | 103 x 103                             | 37             | 0.73                               | 37                     |
| 100 x 100                             | 118 x 118                             | 37             | 1.00                               | 44                     |
| 120 x 120                             | 138 x 138                             | 37             | 1.44                               | 53                     |
| 140 x 140                             | 158 x 158                             | 37             | 1.96                               | 62                     |
| 150 x 150                             | 168 x 168                             | 37             | 2.25                               | 66                     |
| 160 x 160                             | 178 x 178                             | 37             | 2.56                               | 70                     |
| 180 x 180                             | 198 x 198                             | 39             | 3.24                               | 79                     |
| 70 x 100                              | 88 x 118                              | 36             | 0.70                               | 37                     |
| 100 x 140                             | 118 x 158                             | 37             | 1.40                               | 53                     |
| 100 x 150                             | 118 x 168                             | 37             | 1.50                               | 55                     |
| 100 x 200                             | 118 x 218                             | 39             | 2.00                               | 66                     |
| 140 x 200                             | 158 x 218                             | 39             | 2.80                               | 75                     |
| 120 x 250                             | 138 x 268                             | 39             | 3.00                               | 81                     |
| 150 x 300                             | 168 x 318                             | 37             | 4.50                               | 99                     |
| 160 x 250                             | 178 x 268                             | 37             | 4.00                               | 90                     |
| 195 x 200                             | 213 x 218                             | 39             | 3.90                               | 87                     |
| 195 x 250                             | 213 x 268                             | 39             | 4.88                               | 98                     |
| 195 x 300                             | 213 x 318                             | 39             | 5.85                               | 109                    |

Contact us for other dimensions.  
\* For an upstand height of 310 mm

## Filling performance

Other filling and filling options: see "Filling" data sheet.

| Type of filling | Thermal transmittance factor Ug (W/ m <sup>2</sup> .K) | LT D65 <sup>(2)</sup> | SF or g <sup>(2)</sup> | Reaction to fire | R <sub>w</sub> (dB) <sup>(3)</sup> |                       |
|-----------------|--|-----------------------|------------------------|------------------|------------------------------------|-----------------------|
|                 | U <sub>hor</sub> <sup>(1)</sup>                        |                       |                        |                  |                                    |                       |
| PCA             | Opal 4-wall PCA 10                                     | 2.9                   | 62%                    | 60%              | B-s1-d0                            | R <sub>w</sub> =19 dB |
|                 | Transparent PCA 10 with Lumira™ aerogel                | ND                    | ND                     | ND               | ND                                 | ND                    |

<sup>(1)</sup> Relative to the horizontal, as per §2.31 of the Th-Bat regulations.

<sup>(2)</sup> Light transmittance LT D65 and solar transmittance SF (TST or g) as per EN 410.

<sup>(3)</sup> Filling insulated against airborne noise R<sub>w</sub>, pink noise R<sub>p</sub> (environment, airport and industrial activities) and road noise R<sub>A,10</sub>, laboratory-measured according to NF EN ISO 140.

## Technical diagrams

### ORIGIN' range

SKYCLAIR PCA

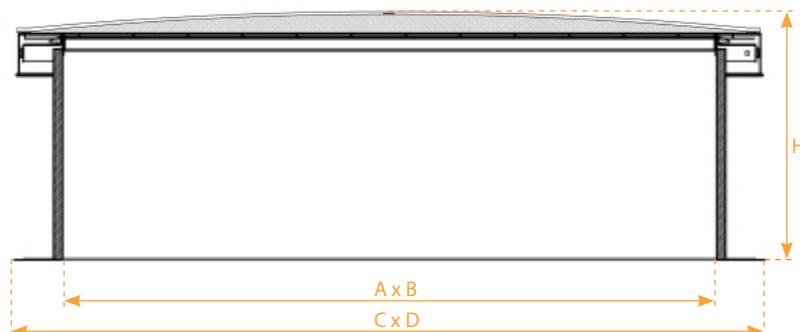

### ORIGIN' range capping upstand

SKYCLAIR PCA

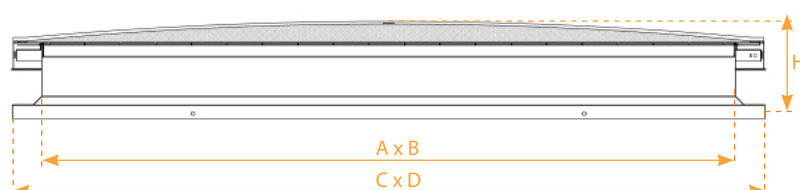

## COMPLIANCE & INSTALLATION

Compliant with EU standard NF EN 1873.

The product must be fastened and sealed in accordance with the requirements defined in the applicable DTU specifications (series 40 and 43).

Maximum insulation height: as per the DTUs, the sealing flashing must extend to a height of at least 150 mm.

The waterproofing complex (substrate, vapour barrier, insulation and two-layer sealant) must be no thicker than 140 mm for an interior upstand height of 310 mm, or 240 mm for an interior upstand height of 410 mm.

Maximum permissible slope: 25° or 46% (see installation instructions).

Only the security bar option provides guaranteed 1200 joule protection.

**DoP available at [www.skydome.eu](http://www.skydome.eu)**

## FOR RENOVATION AND COMPLIANCE WORKS

The SKYCLAIR® CAPPING UPSTAND is designed to fit any type of upstand, whether for compliance reasons or to change the unit's purpose **while retaining the existing upstand**.



### Filling

#### ORIGIN' RANGE:

- Opal PCA 10



### Upstand

- 1.2 mm galvanised steel
- Height 170 mm

#### ORIGIN' RANGE:

- Bevelled adapter upstand with 84 mm heel and 40 mm overlap

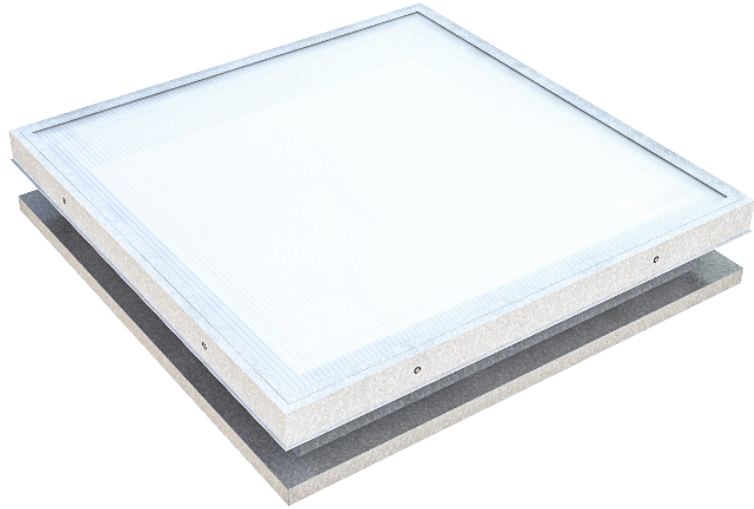

## Installation diagram

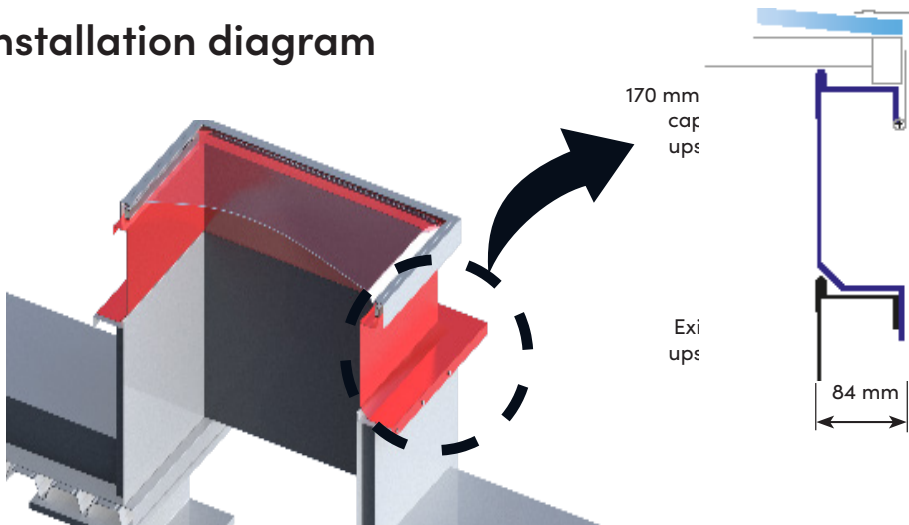

## Options

Standard options list p.1

### Upstand

- Upstand insulation including a galvanised steel protection plate
- Heel width on request for fitting to existing substrate
- Upstand height on request

## Dimensions

| Roof opening dimensions<br>A x B (cm) | Overall heel dimensions<br>C x D (cm) | Height H* (cm) | Light surface<br>(m <sup>2</sup> ) | Product weight<br>(kg) |
|---------------------------------------|---------------------------------------|----------------|------------------------------------|------------------------|
| 50 x 50                               | 67 x 67                               | 22             | 0.25                               | 17                     |
| 85 x 85                               | 102 x 102                             | 23             | 0.73                               | 29                     |
| 100 x 100                             | 117 x 117                             | 23             | 1.00                               | 34                     |
| 120 x 120                             | 137 x 137                             | 23             | 1.44                               | 40                     |
| 140 x 140                             | 157 x 157                             | 23             | 1.96                               | 47                     |
| 150 x 150                             | 167 x 167                             | 23             | 2.25                               | 50                     |
| 160 x 160                             | 177 x 177                             | 23             | 2.56                               | 54                     |
| 180 x 180                             | 197 x 197                             | 25             | 3.24                               | 60                     |
| 70 x 100                              | 87 x 117                              | 24             | 0.70                               | 29                     |
| 100 x 140                             | 117 x 157                             | 22             | 1.40                               | 40                     |
| 100 x 150                             | 117 x 167                             | 23             | 1.50                               | 42                     |
| 100 x 200                             | 117 x 217                             | 23             | 2.00                               | 50                     |
| 140 x 200                             | 157 x 217                             | 25             | 2.80                               | 57                     |
| 120 x 250                             | 137 x 267                             | 25             | 3.00                               | 62                     |
| 150 x 300                             | 167 x 317                             | 25             | 4.50                               | 76                     |
| 160 x 250                             | 177 x 267                             | 25             | 4.00                               | 69                     |
| 195 x 200                             | 212 x 217                             | 25             | 3.90                               | 66                     |
| 195 x 250                             | 212 x 267                             | 25             | 4.88                               | 75                     |
| 195 x 300                             | 212 x 317                             | 25             | 5.85                               | 83                     |

Contact us for other dimensions.  
\* For an upstand height of 170 mm

---

## SKYDÔME

Entre Deux Villes  
02270 Sons-Et-Ronchères, France  
Tel: +33 (0)3 23 21 79 90  
[www.skydome.eu](http://www.skydome.eu)

For the product range in other countries, please contact your local representative or visit [www.skydome.eu](http://www.skydome.eu).

SKYDÔME reserves the right to modify product specifications without notice. The information and technical details contained in this documentation are provided in good faith and apply to the uses described. The recommendations for use must be checked to ensure they are appropriate and comply with the actual requirements, the specifications and all applicable legislation and regulations.

For other applications and conditions of use, please contact our technical team. Their advice must be sought concerning uses of our products that are not described specifically herein.

Click this link to check that you are seeing the most up-to-date and accurate information about our products:  
[https://www.skydome.eu/fr/produit/8\\_skyclair.html](https://www.skydome.eu/fr/produit/8_skyclair.html)